

BIENVENIDO



Julio 2024



Cdcsuministros.cl



CDC SUMINISTROS

Curso: Instaladores Panel SIP



Julio 2024



Cdcsuministros.cl

Ramo III

Acabados y Detalles técnicos

▶ **UNIDAD 5**
Estructura de techos y entrepisos

▶ **UNIDAD 6**
Instalaciones

▶ **UNIDAD 7**
Membranas y revestimientos.



UNIDAD 5

Estructura de techos y entrepiso

- Tipos de techos y su instalación
- Ensamblajes entrepisos y consejos prácticos
- Mejoras estructurales



Tipos de Techumbres

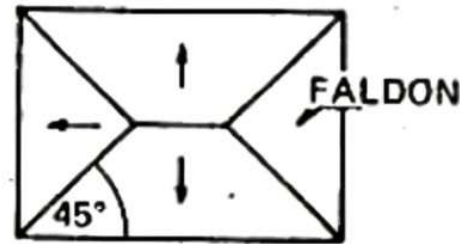
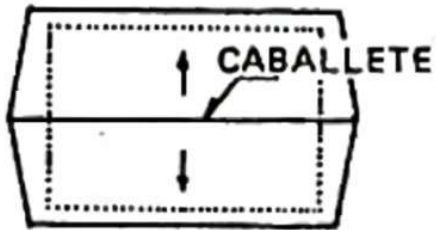
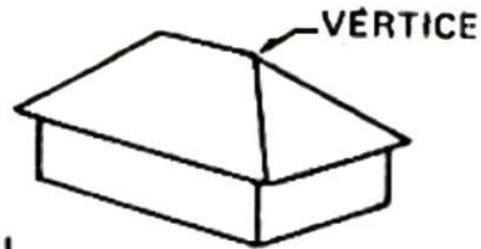
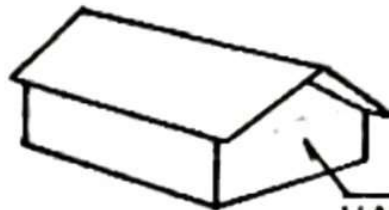
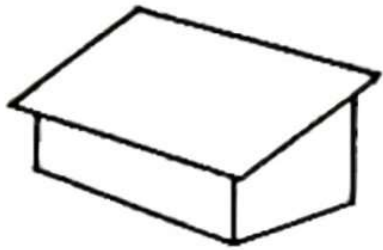

A UNA AGUA
o MEDIAGUA

A DOS AGUAS

A CUATRO AGUAS
o CON FALDÓN









Instalación de Techumbre

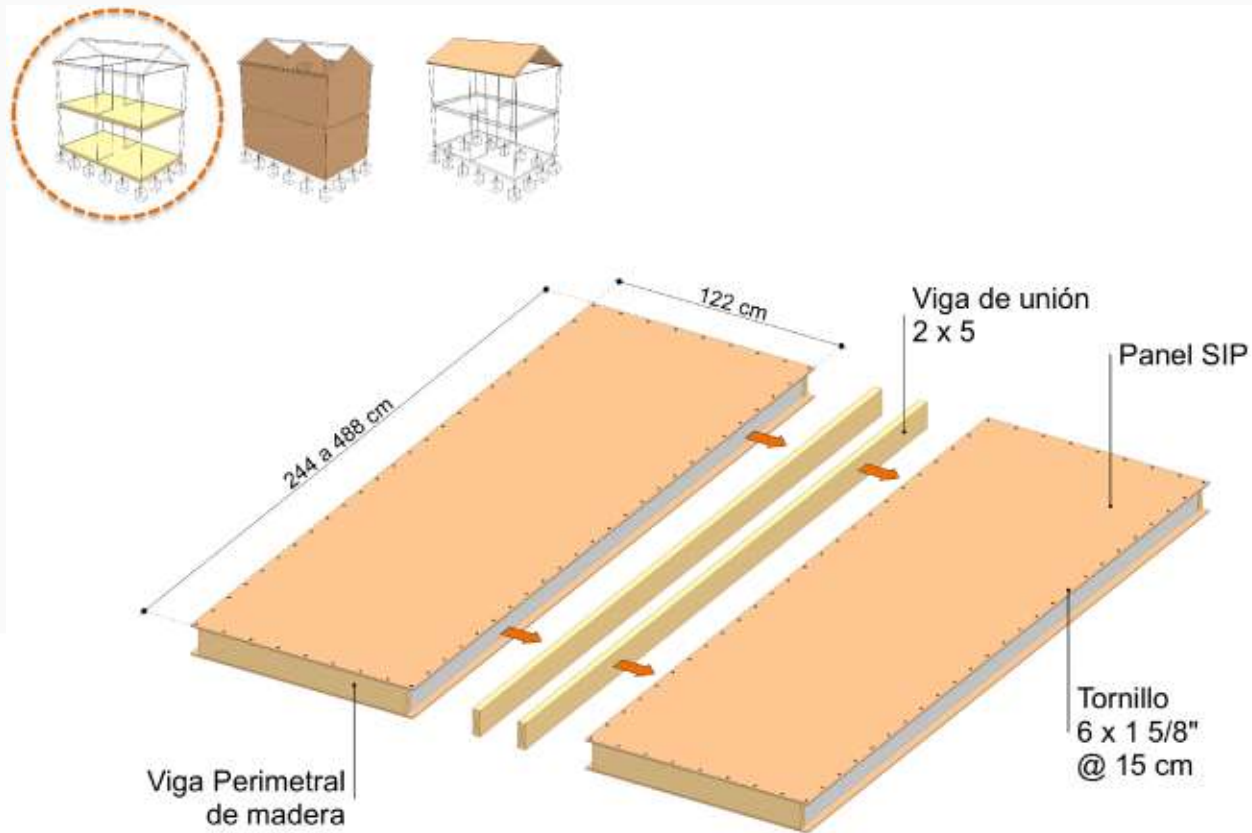

Instalación de Techumbres

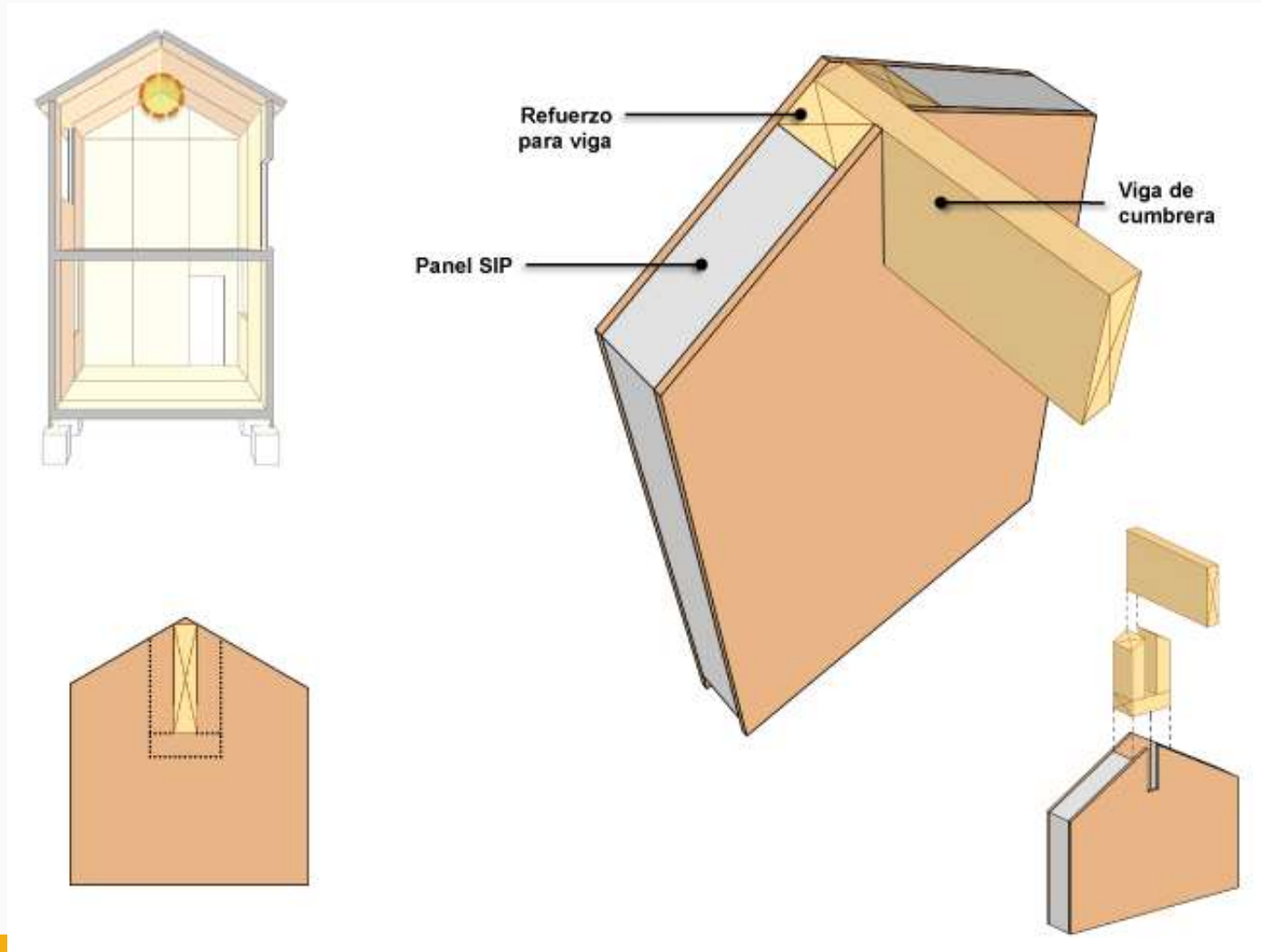

Instalación de Techumbres

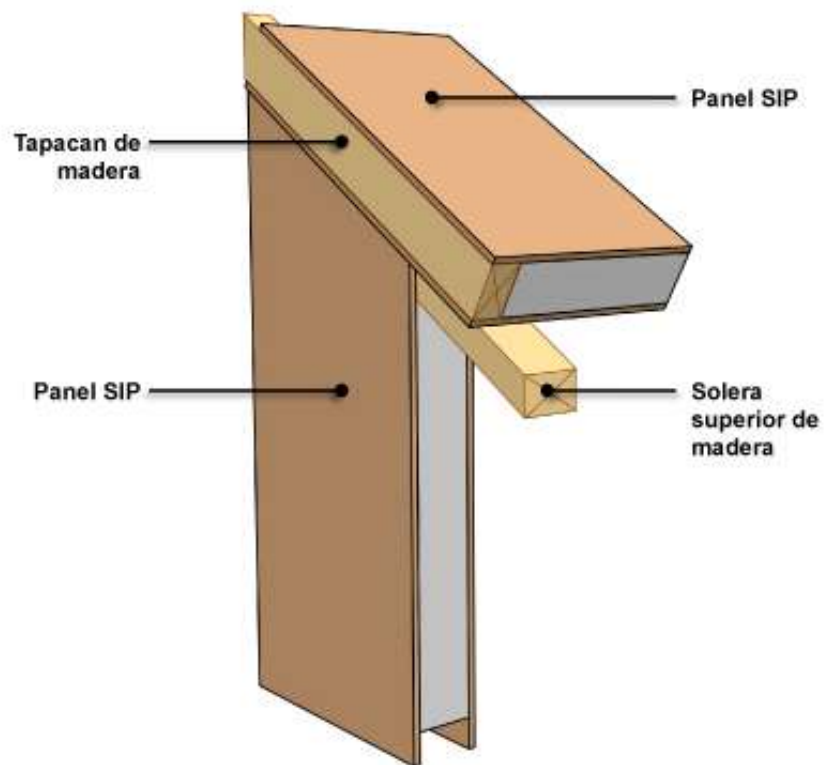
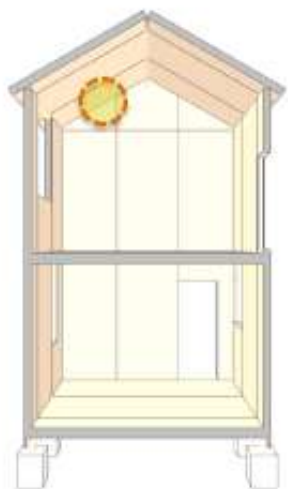

Instalación de Techumbres

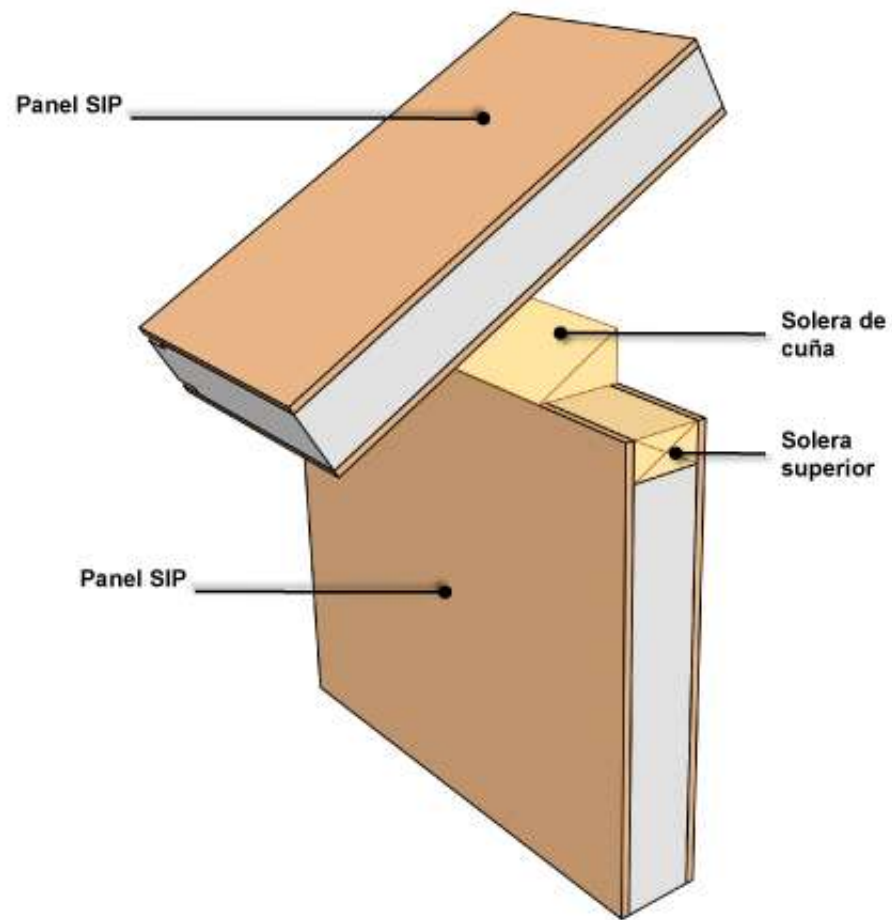
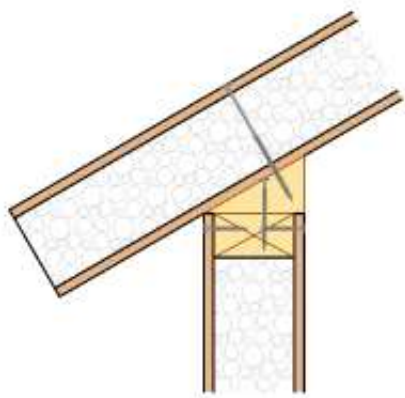

Ensamblajes entrepiso

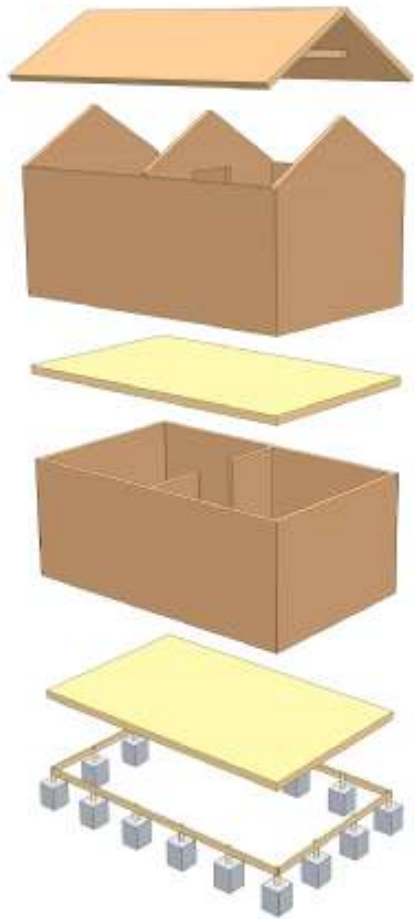

Cubierta apoyada en una viga de cumbrera y en los muros laterales

Muros formando encuentros en "L" o "T", con frontones para dar pendiente a la cubierta. Todos apoyados sobre la losa

Losa apoyada sobre muros de 1º Piso

Muros formando encuentros en "L" o "T", y apoyados sobre la losa

Losa apoyada sobre envigado o fundación corrida

Fundaciones aisladas con envigado o Fundaciones corridas

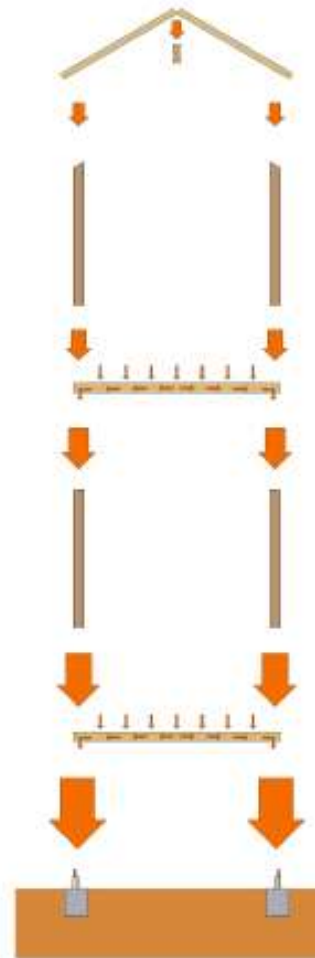

Ensamblajes entrepiso

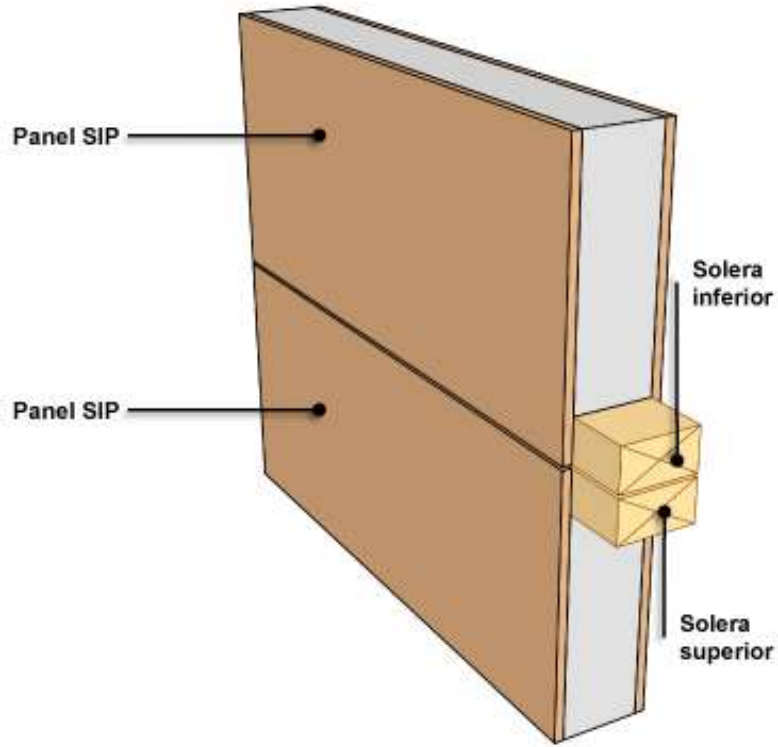
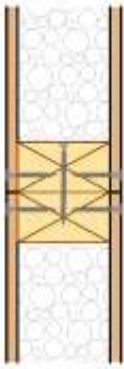
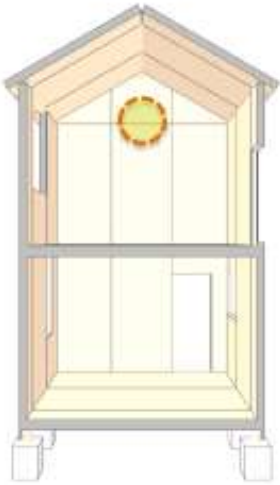

Ensamblajes entrepiso

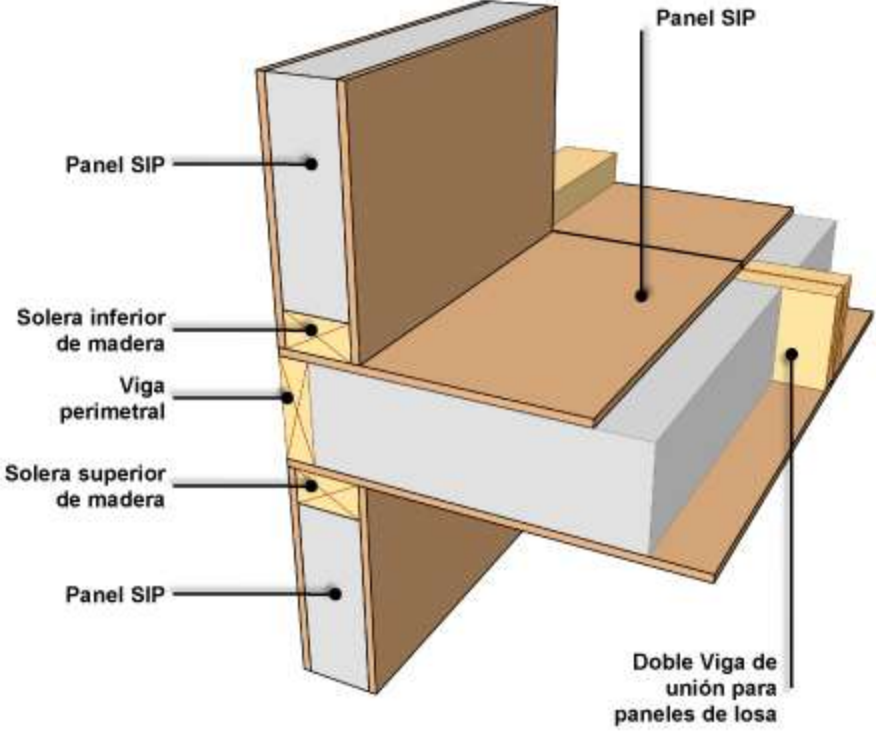
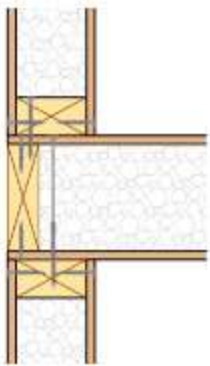

Ensamblajes entrepiso

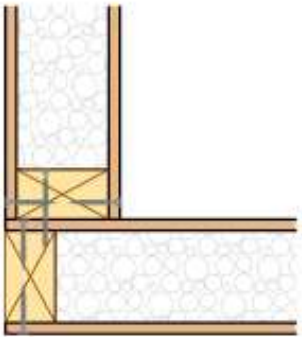
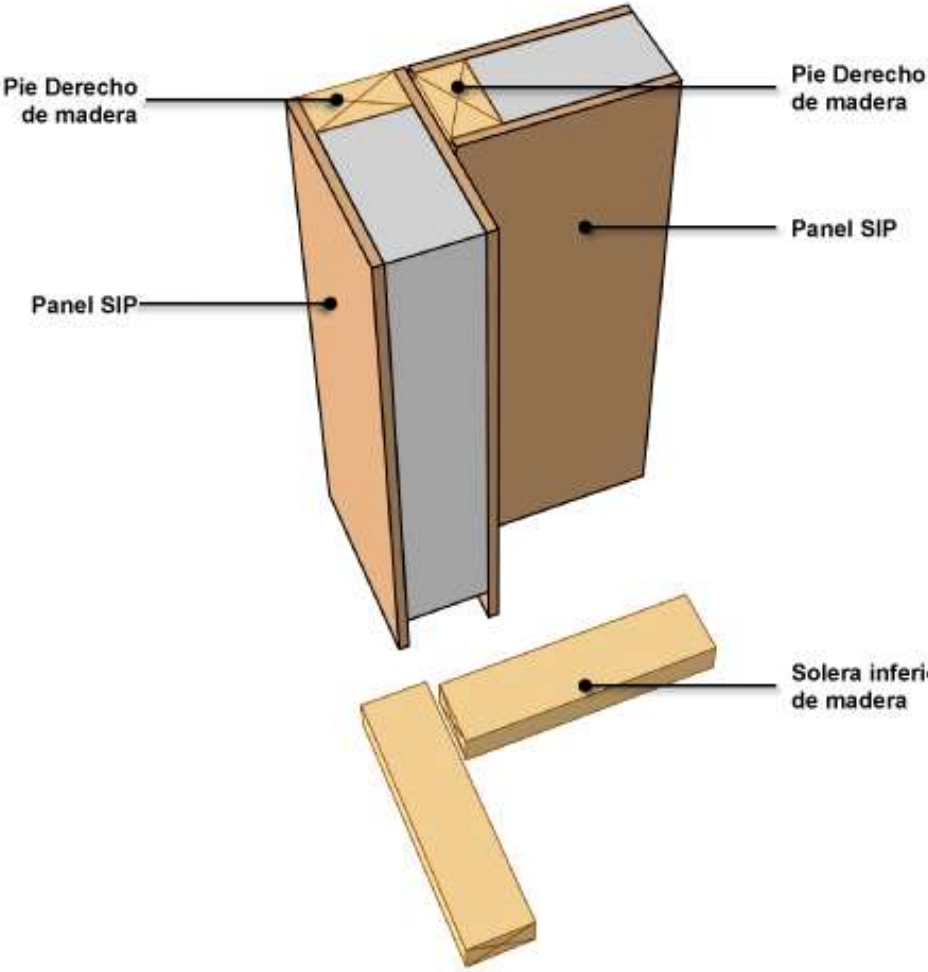
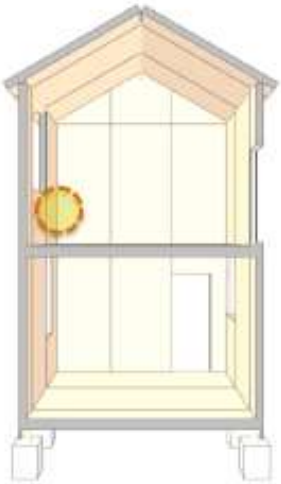

Ensamblajes entrepiso

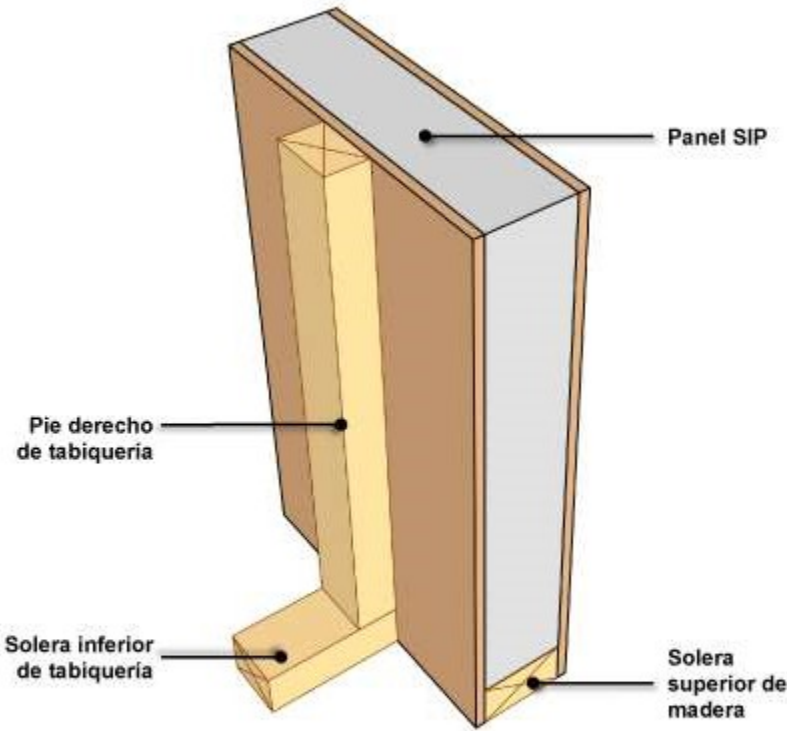
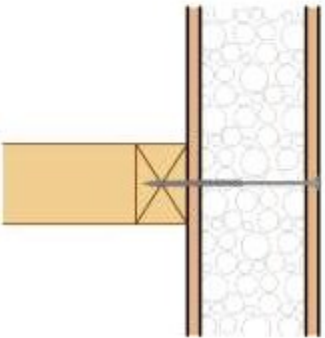
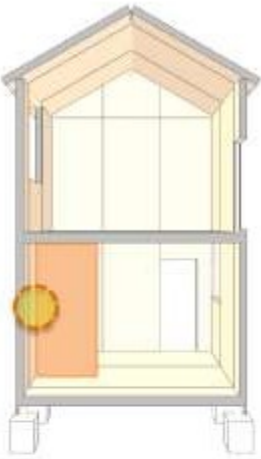

Mejoras Estructurales Muros Aleta

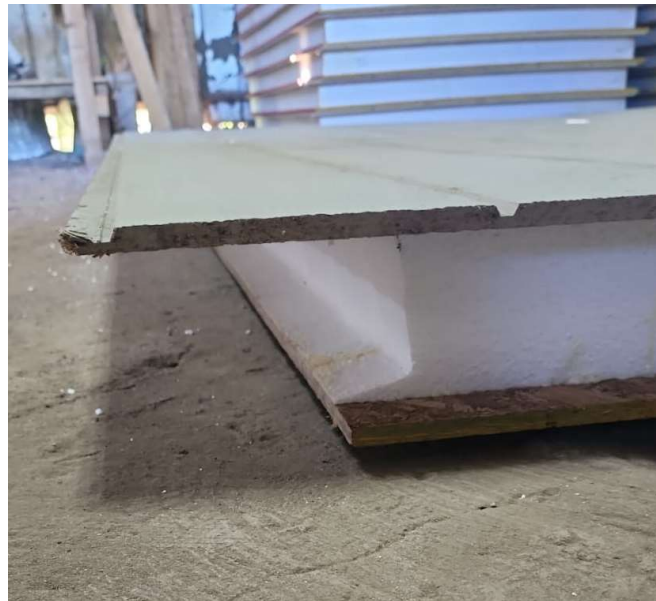

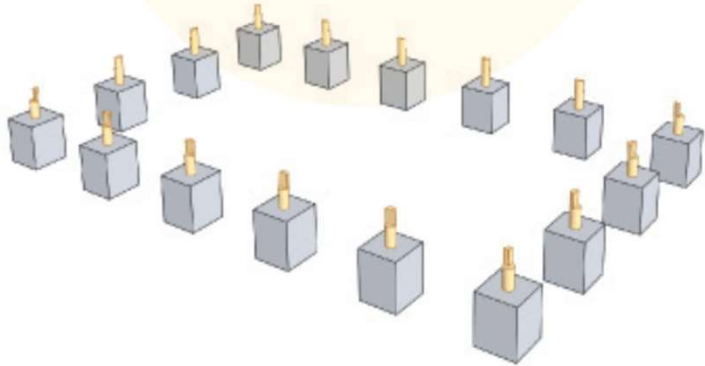
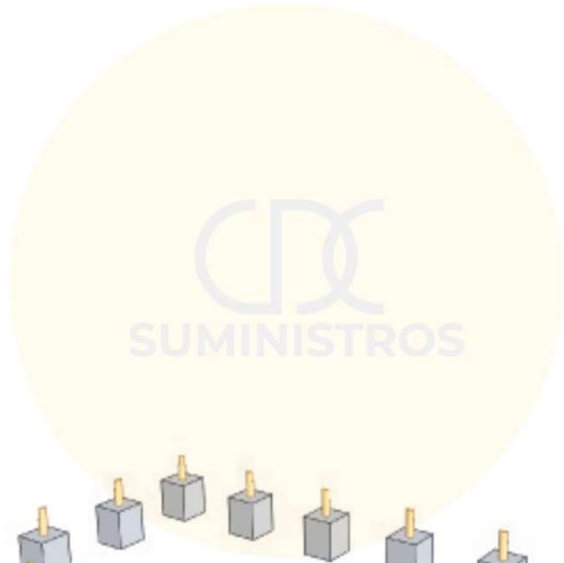

UNIDAD FINALIZADA



Julio 2024



Cdcsuministros.cl